

7b

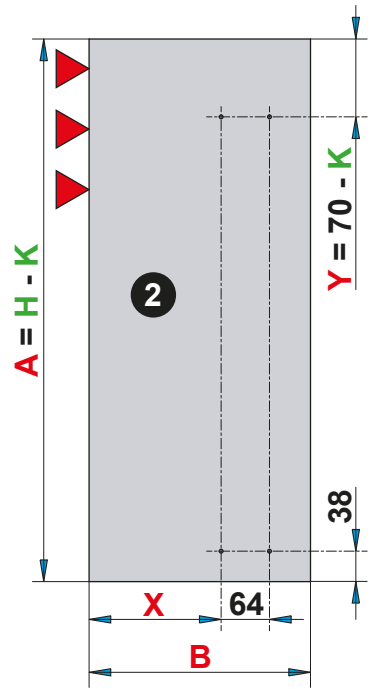

S	X
550	193,5 - M
555	188,5 - M
560	183,5 - M
565	178,5 - M
570	178,5 - M
575	178,5 - M
580	178,5 - M

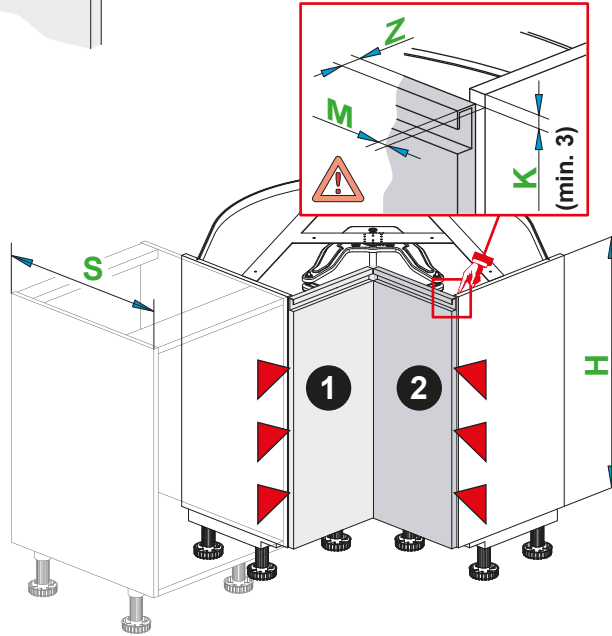

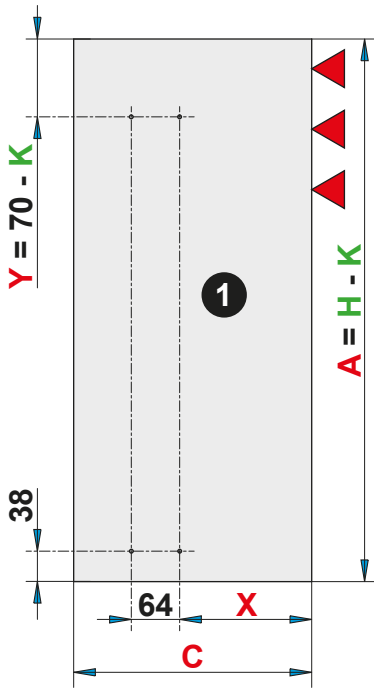
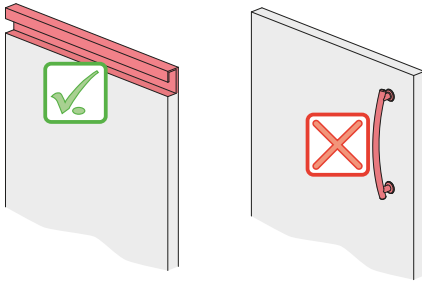
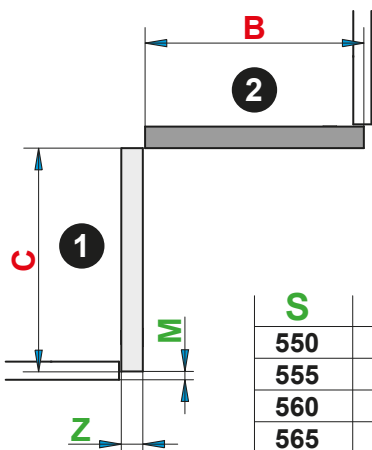

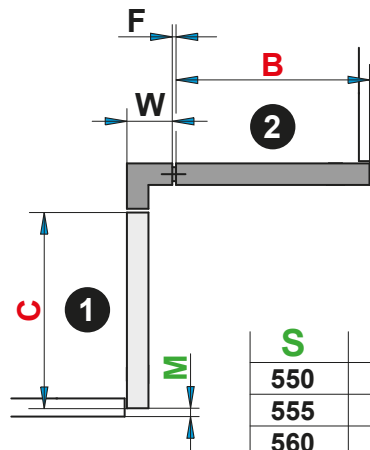



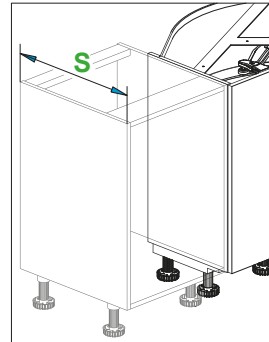
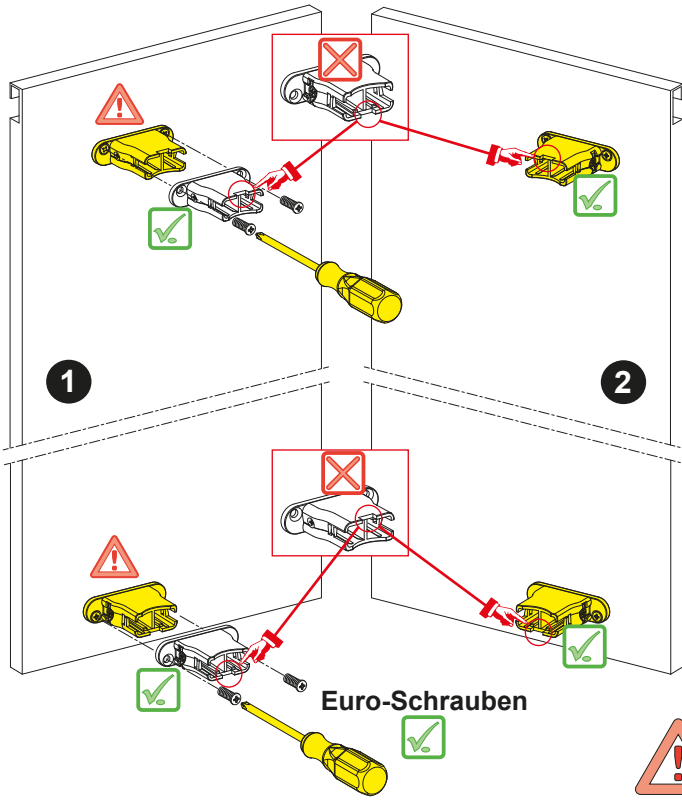

S	B = C
550	346 - M - Z
555	341 - M - Z
560	336 - M - Z
565	331 - M - Z
570	326 - M - Z
575	321 - M - Z
580	316 - M - Z

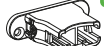

S	B = C
550	348 - F - M - W
555	343 - F - M - W
560	338 - F - M - W
565	333 - F - M - W
570	328 - F - M - W
575	323 - F - M - W
580	318 - F - M - W

8b



S	
550	 ✓
555	 ✓
560	 ✓
565	 ✓
570 X = 2	 ✓
575 X = 4	 ✓
580 X = 6	 ✓

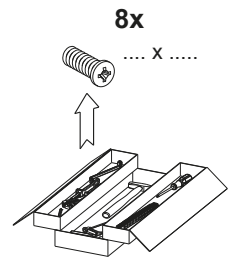
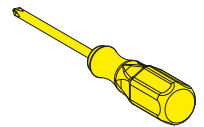
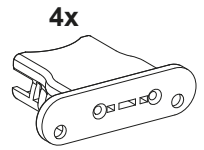

9b

