

Switching ON/OFF

Ein-/Ausschalten
Mise en marche/arrêt

 2 sec = OFF



Power adjustment

Leistungseinstellung
Ajustement de puissance

 100-75-50%



Status LED

LED Status
Etat LED



 Normal operation
Normaler Betrieb
Fonctionnement normal

 Instrument locked
Gerät gesperrt
Instrument bloqué

 Low battery
Tiefer Batteriestand
Batterie faible

 Out of level
Ausserhalb des
Selbstnivellierbereichs
Hors du niveau

Adapter Setup

Adapter-Einrichtung
Configuration de l'adaptateur

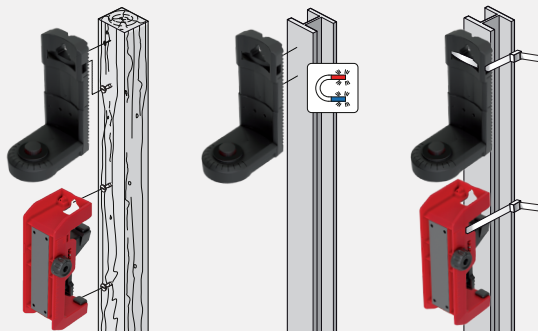

Usable with UAL 130

Verwendbar mit UAL 130
Utilisable avec UAL 130

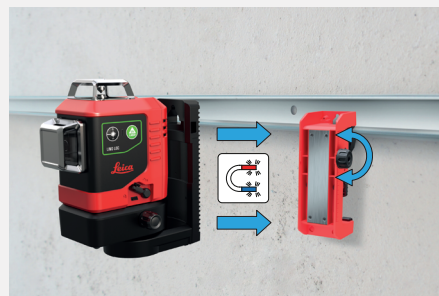

Usable with Receiver

Verwendbar mit Empfänger
Utilisable avec récepteur

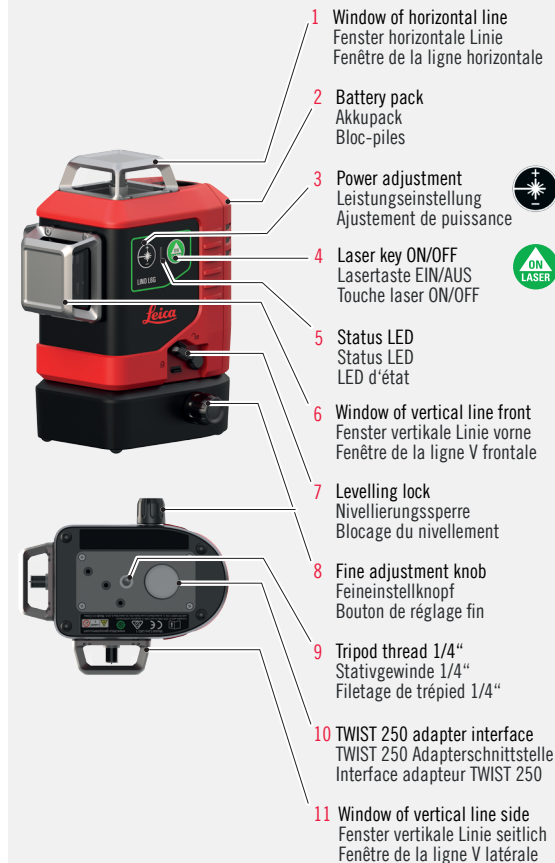
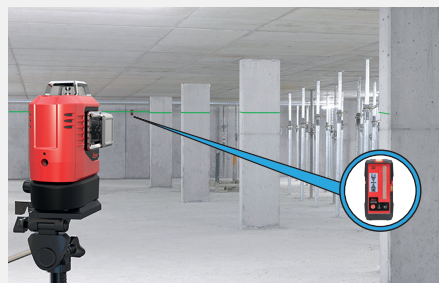

Quick Start

Schnellstartanleitung

Guide de prise en main rapide

Leica Lino L6G



- when it has to be right

Leica
Geosystems

Insert batteries/Li-Ion
Batterien/Li-Ion einlegen
Insérer des piles/Li-Ion



**1x - Laser on/
Vertical + horizontal mode**
1x - Laser an/ vert. + horizont. Modus
1x - Laser on/mode vert. + horizont.

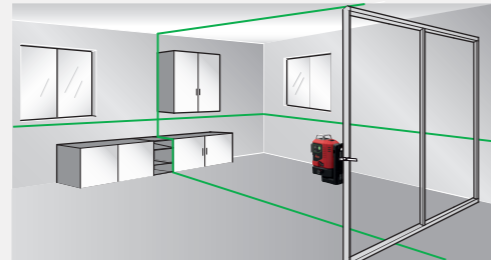

3x - Layout mode
3x - Absteck Modus
3x - Mode Implantation

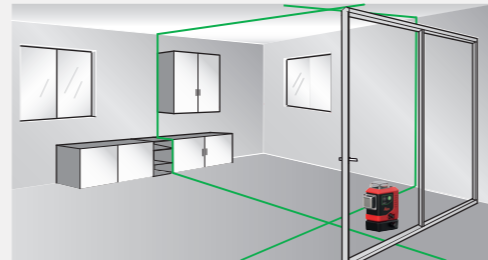

Horizontal mode
Horizontaler Modus
Mode horizontal



Vertical mode
Vertikaler Modus
Mode vertical

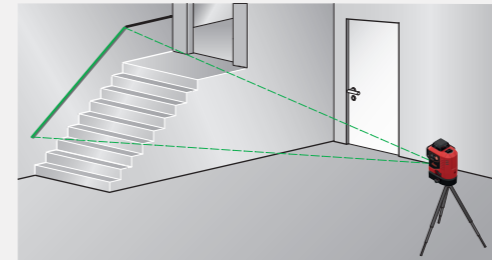

Transport



Charging Li-Ion battery
Li-Ion Batterie aufladen
Charger batterie Li-Ion



2x - All on mode
2x - All-on Modus
2x - Mode all on

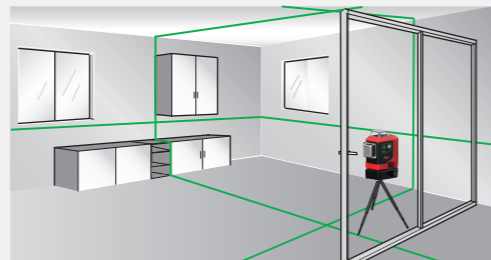

4x - Horizontal mode
4x - Horizontaler Modus
4x - Mode horizontal

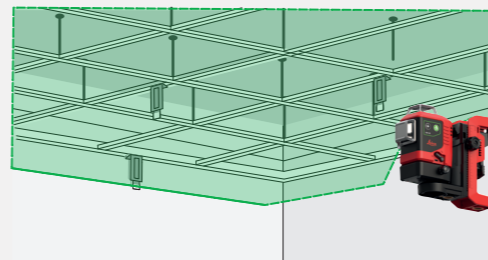

Self levelling/Levelling lock
Selbstnivellierung/Nivellierungssperre
Auto-nivellement/blocage du nivellement

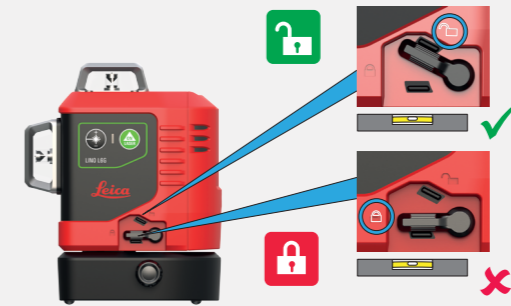

User Manual
Bedienungsanleitung
Manuel d'utilisation



www.leica-geosystems.com

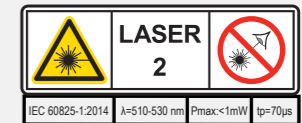

IEC 60825-1:2014 λ=510-530 nm Pmax:<1mW tp=70µs

SAP- No. 913009